

# SD Series

Ultra-slim user-friendly devices for protecting electronic equipment and systems against surges on signal and I/O cabling

- **Range of ATEX Certified intrinsically safe surge protectors**
- **Ultra-slim space-saving design; easy installation**
- **Multistage hybrid protection circuitry – 20kA maximum surge current**
- **Range of voltage ratings – to suit all process I/O applications**
- **High bandwidth, low resistance, RTD, PSTN and 3-wire transmitter versions available**
- **10 year product warranty**



**The SD Series** is a range of surge protection devices combining unparalleled packing densities, application versatility, proven reliable hybrid circuitry, simple installation and optional 'loop disconnect' facilities – features which make the series the ultimate surge protection solution for process equipment, I/O systems and communications networks.

**The exceptionally high packing densities** are the consequence of an ultra slim 'footprint' for individual modules which can thus 'double-up' as feedback terminals. Each module provides full hybrid surge protection for 2 and 3 wire loop protection.

**Modules with a comprehensive range of voltage ratings** cover all process related signals such as RTDs, THCs, 4 to 20mA loops, telemetry outstations, shut-down systems and fire and gas detectors.

**Optional 'loop disconnect'**, is a feature which allows commissioning and maintenance to be carried out without removal of the surge protection device. This facility

is provided by the SD07, SD16, SD32 and SD55 units. In addition, a third connection on the field and safe side of the protector is provided in order to terminate screens safely.

**For three wire applications** the specially designed SDRTD (Resistance Temperature Detector) and the SD32T3, (for separately powered 4-20mA loops) provide full 3-wire protection in a single compact unit. The recommended choice for the protection of 3-wire pressure transducers on low power circuits is the SDO7R3.

**For higher bandwidth applications**, the SDR series has been developed to meet the demands of today's highest speed communication systems.

**120V and 240V AC versions** are available for I/O and power supplies up to three Amps of load current.

**Telephone networks** can be protected by the SDPSTN.

**One simple manual operation** clamps modules securely onto DIN rail, which automatically provides the essential high-integrity earth connection.

**'Top-hat' (T-section) DIN rail** is generally suitable for mounting SD modules although for adverse environments, a specially-plated version is available from MTL Surge Technologies. A comprehensive range of mounting and earthing accessories can also be supplied, see page 7 for further details.

**SIL  
SUITABLE**

## Data & Signal Protection

# Guide to applications and selection

The SD Series of SPDs includes models for almost all possible applications operating at voltages up to 250V ac. The optional 'fuse/disconnect' package provides both fused protection against fault currents and a convenient method of isolating field circuitry from protected circuitry without needing additional disconnect terminals. The standard fuse (which is replaceable) is rated 250mA with 50mA fuses also being available by special request. Where only the disconnect feature is required, solid links can be used.

As an example, this feature is of particular value in applications in which an SPD is used with a bulk power supply feeding multiple loops. The individual module fuse prevents a fault or follow on current on one loop disrupting the power supply to the others. Also, loops can be removed from the circuit for maintenance reasons or added without needing additional disconnect terminals.

The following guide to selection suggests the most suitable SDs for a number of specific applications. For technical information, see the detailed specifications on the back page of this publication (some field circuit protection is shown for completeness).

## Analogue inputs (high-level)

### 2-wire transmitters, 4-20mA, conventional and smart

The SPDs recommended for use with 'conventional' and 'smart' 4-20mA transmitters (fed by a well-regulated supply) are the SD32 and SD55, the choice depending upon the maximum working voltage of the system (32V and 55V respectively). The diagram illustrates a prime example of an application for which the fuse/disconnect facility is particularly useful, however; both models are available in 'X' versions without the optional fuse/disconnect feature.

#### FIELD CIRCUIT

#### PROTECTED CIRCUIT

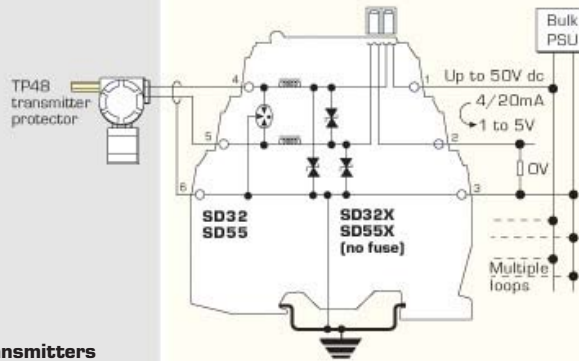

2-wire transmitters

## Analogue inputs (low-level)

### RTDs

These applications are best served using the SDRTD. For optimum accuracy, the energising current should be chosen to ensure the voltage across the RTD does not exceed 1V over the full measurement range. When using a PT100 device, we recommend an energising current of 1mA.

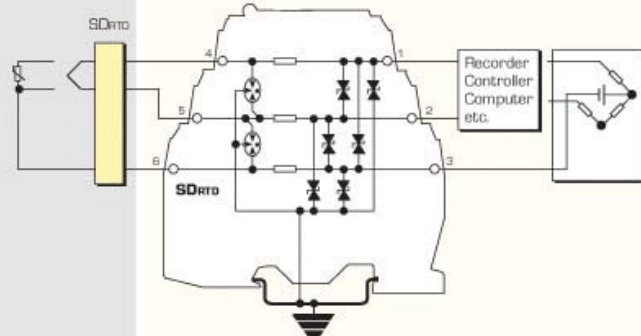

3-wire RTDs

### photocells, THCs, mV sources and turbine flowmeters

The SD07 or SD16 (depending upon the operational voltage) are the favoured choices for this application. SD07X and SD16X are also suitable.

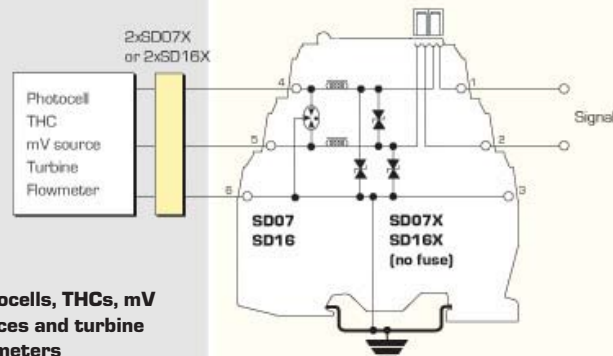

photocells, THCs, mV sources and turbine flowmeters



## Analogue outputs

### Controller outputs (I/P converters)

For this application, the recommendations are the SD16, SD32 and SD55 (and the equivalent 'X' versions), the final choice depending upon the operating voltage.

## Digital (on/off) inputs

### Switches

Suitable SPDs for switches include the SD07, SD16, SD32 and SD55 modules – the choice depending upon the operating voltage of the system. The 'X' versions of these are also suitable.

## Digital (on/off) outputs

### Alarms, LEDs, solenoid valves, etc

The recommended choice for this application is the SD32 or SD32X.

## Telemetry (PSTN)

### Telemetry outstations

The SDPSTN has been designed specifically for the protection of signals transmitted on public switched telephone networks.

## AC supplied equipment

### PLC, I/O systems

For systems on 110-120V ac, the SD150X is the recommended choice and for 220-240V ac systems, the SD275X is recommended.

## FIELD CIRCUIT

## PROTECTED CIRCUIT

2xSD16X, SD32X

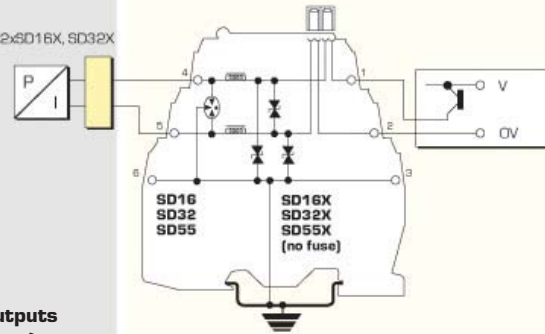

### Controller outputs (I/P converters)

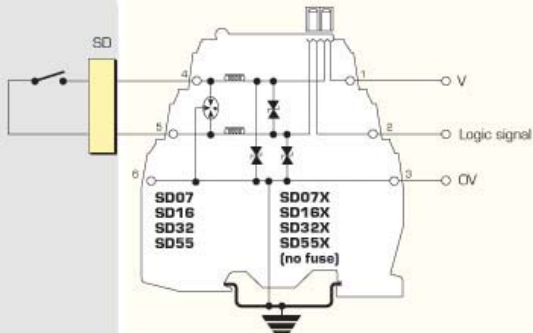

### Switches

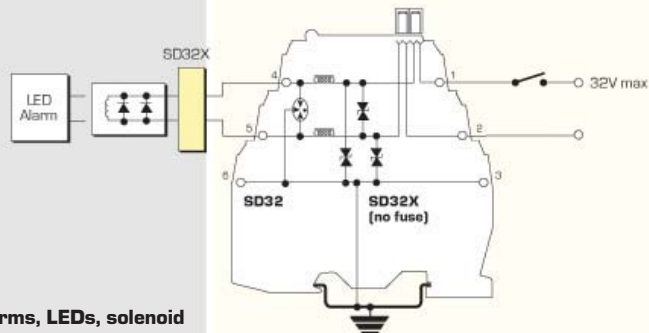

### Alarms, LEDs, solenoid valves, etc.

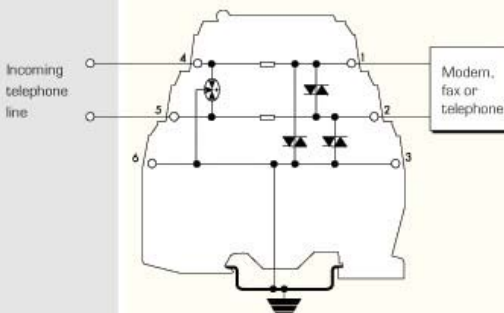

### Telecom line

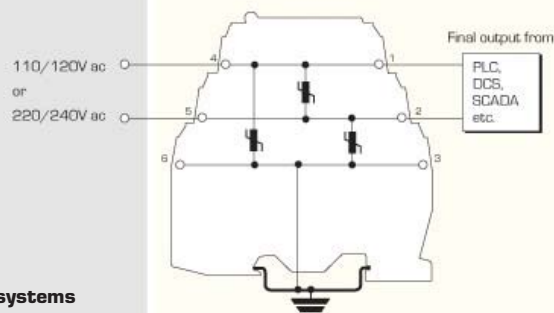

### PLC, I/O systems

# Transmitter and sensor protection

Transmitters and sensors are widely used in highly exposed areas and where lightning damage is common. In many cases, the ideal solution for 2-wire transmitters or sensors is the TP48 which mounts directly onto the transmitter housing via spare cable entries. Where these entries are not available or 3-wire devices are used, the compact design and simple installation of the SD series makes it the obvious choice for transmitter protection.

The SDs within the junction box should be installed no further than one metre away but as close as possible to the sensor or transmitter they are protecting. A bond is required from the general mass of steelwork to the sensor or transmitter housing either using a flat short braid or a cable of at least 4mm<sup>2</sup> cross sectional area. In most instances this bond is automatically made by fixing the metallic transmitter housing to the plant structure. This bond ensures the voltage difference between the signal conductors and the transmitter housing is below the transmitter's insulation rating. Please note that the transmitters or sensors are connected to the 'Protected Equipment' terminals of the SD and not the 'Field Cables'.

## 2-wire transmitters or sensors

### 4-20mA transmitters, conventional and smart

Where the TP48 is not an acceptable solution, either because of technical suitability or difficulties in mounting, the SD16X, SD32X and SD55X are an excellent alternative.

## 3-wire transmitters or sensors

Vibration Sensors and 4-20mA loop process control systems invariably require three wire connections, when powered from an external source.

This may be accomplished in one unit by using the SD32T3 three terminal Surge Protection Device (SPD).

Because the SD32T3 protects all three conductors within the same unit, higher protection is achieved, as the SPD hybrid circuitry is common to all three wires.

The SD07R3 is available for the protection of 3-wire pressure transducers on low power circuits.

## 4-wire transmitters or sensors

### Flow meters, level detectors, etc.

4-wire systems such as level detectors require two SDs, one for the supply and the other for the transmitter output. Generally the voltages across the pairs are similar and so the recommended choice would be a pair of SD16X, SD32X or SD55Xs. However, mains powered transmitters should be protected with an SD150X or 275X (depending upon supply voltage) for the supply inputs.

Loadcells are catered for by MTL Surge Technologies' LC30 which is suitable for both 4 and 6-wire load cells.

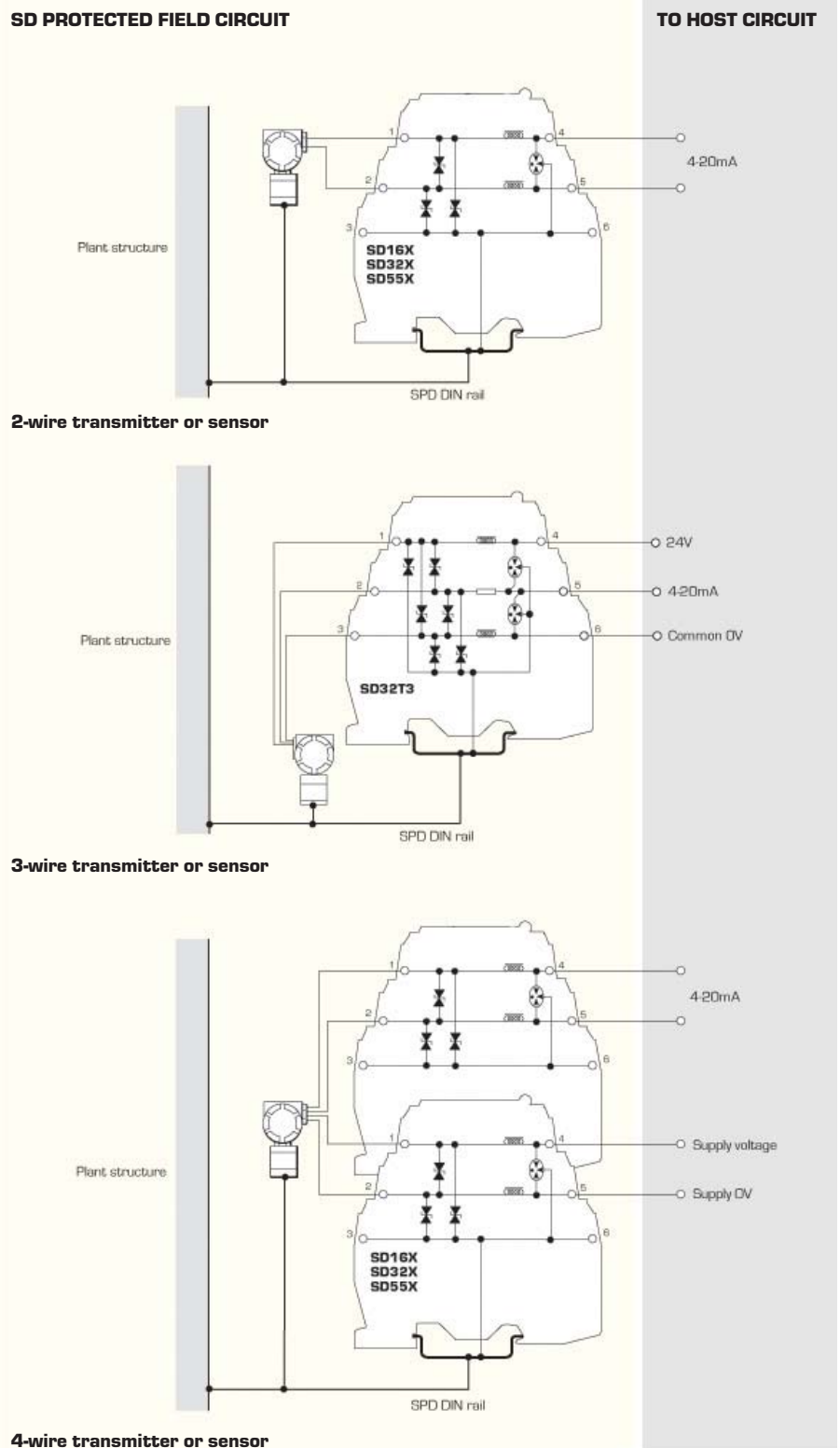

# Communication systems protection

High speed data links between buildings or one part of a plant to another have become more common with the widespread use of smart transmitters and the increase in unmanned installations. The SD series has an SPD suitable for all process I/O applications with a choice of low resistance units, high bandwidth and a variety of voltage variants. The SDR series has been specially designed to meet the requirements for high speed data links with an extremely high bandwidth.



## Communication systems

### RS232, RS422, RS485

The recommended choice for these applications is the SD16R or SD32R depending on the maximum driver signal.

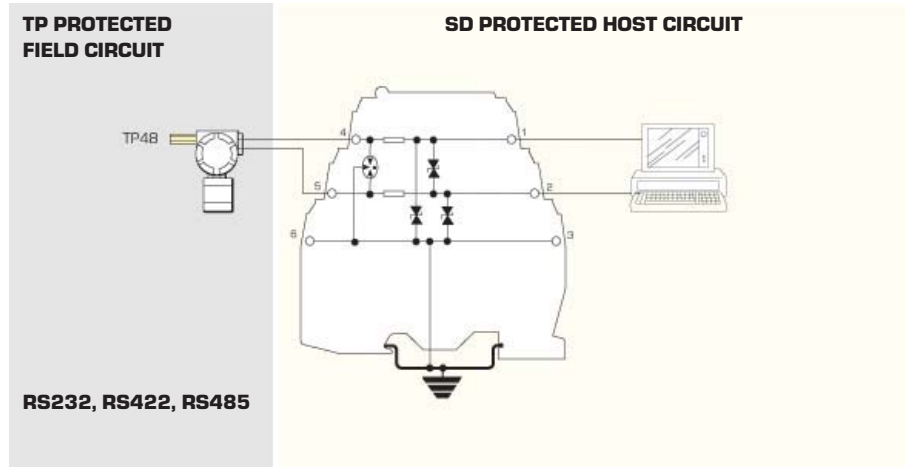

## Bus powered systems

There are a variety of bus powered systems specially designed for the process industry. The ideal surge protection device for these systems is the SD32R as it has a very high bandwidth and a modest in-line resistance.

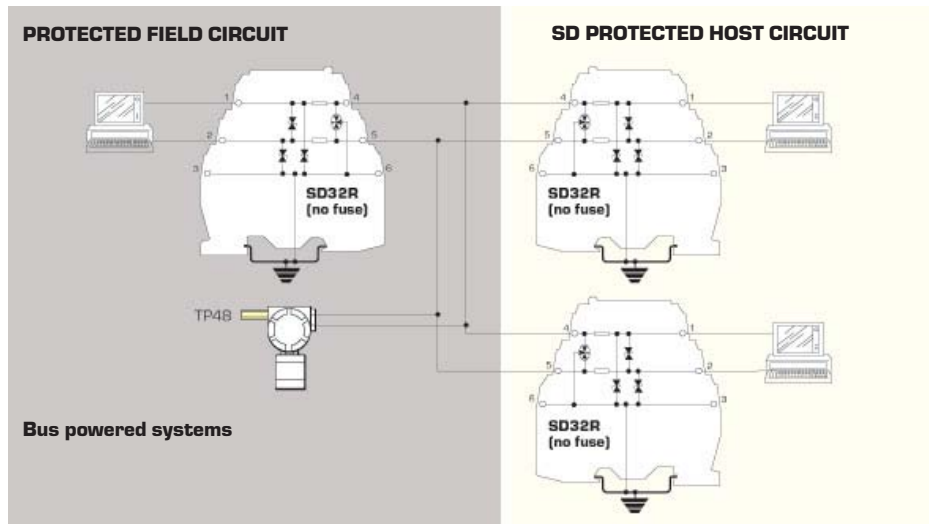

## Typical Applications

Table 1 shows suitable SD devices for different applications. In some applications alternative devices may be used, for example, where lower in-line resistance or a higher voltage power supply is used.

MTL Surge Technologies has operationally tested the recommended SD series with representative highways listed but no formal approval for their use in systems by the respective bodies has been sought.

**Table 1**

Application	Preferred SPD	Alternative
Allen Bradley Data Highway Plus	SD16R	
Foundation Fieldbus	SD32R	
31.25kbits/s voltage mode	SD55R	
1.0/2.5 Mbits/s	SD32X	SD32, SD32R
HART	SD32X	SD32, SD32R
Honeywell DE	SD32X	
LonWorks		
FFT-10	SD32R	
LPT-10	SD55R	
TP-78	SD07R	
IS78†	SD32R	
Modbus ' & Modbus Plus (RS485)	SD16R	
PROFIBUS		
DP	SD32R	
PA (IEC 1158, 31.25 kbits/s)	SD32R	
RS232	SD16	SD16X
RS422	SD07R	
RS423	SD07R	
RS485	SD07R	
WorldRP (IEC 1158)	SD32R	
31.25 kbits/s voltage mode		
1.0/2.5 Mbits/s	SD55R	

# Hazardous area applications

## Zone 0/Zone 1

The dangers from lightning induced sparking in Zone 0 are considered real enough to require preventative measures. IEC 60079-14 (1996-12) Electrical apparatus for explosive gas atmospheres Part 14: Electrical installations in hazardous areas (other than mines) stresses the importance of SPDs in hazardous areas. An outdoor installation where there is a high likelihood of both lightning induced transients and combustible gases requires the installation of SPDs to prevent possible ignition of the gases. Areas seen particularly at risk include flammable liquid storage tanks, effluent treatment plants, distillation columns in petrochemical works and gas pipelines.

SPDs for transmitter protection should be installed in Zone 1 but sufficiently close to the Zone 0 boundary to prevent high voltages entering Zone 0. The distance from the SPD to Zone 0 should be less than one metre where possible. However, in practice the SPD would normally be mounted on the transmitter or sensor housing which usually lies in Zone 1 and is very close to Zone 0. Because there is only a very small free volume, the SD Series is suitable for mounting in flameproof or explosion proof enclosures.

## Zone 2

The SD series is suitable for protecting electrical circuits in Division 2, Zone 2 and can be used without affecting the safety aspects of the circuit. Non-incendive (low-current) circuits can be protected using any SD series unit mounted in either the safe or hazardous area including those with the fuse disconnect facility. Non arcing (high current) circuits can also be protected except that SPDs with the fuse disconnect facility may only be mounted in the safe area. For use in these circuits the units must be mounted in a suitable enclosure, normally the minimum requirements are IP54 and 7Nm resistance to impact. The SD series is self certified by MTL Surge Technologies as being suitable for this purpose.

## Certification

Introducing surge protection into Intrinsically Safe (IS) circuits is trouble free as long as the current and power parameters are not exceeded. In the SD Series, the SD\*\*X, SD\*\*R, SD\*\*R3, SDRTD and SD\*\*T3 all have ATEX certification for use in IS circuits located in Zones 0, 1 or 2. The certification parameters for the SD\*\*X and SD\*\*T3 are:

- EEx ia IIC T4**,  $L_i = 0.22\text{mH}$
- $I_i = 260\text{mA}$  for  $U_i$  up to 20V
- $I_i = 175\text{mA}$  for  $U_i$  up to 26V
- $I_i = 140\text{mA}$  for  $U_i$  up to 28V
- $I_i = 65\text{mA}$  for  $U_i$  up to 60V

The certification parameters for the SD\*\*R, SD\*\*R3 and SDRTD are:

- EEx ia IIC T4**,  $L_i = 0$
- $I_i = 260\text{mA}$  for  $U_i$  up to 60V

The power rating for each of these is dependent on the table shown below.

- $P_i = 1\text{W}$  (-30°C to +75°C)
- $P_i = 1.2\text{W}$  (-30°C to +60°C)
- $P_i = 1.3\text{W}$  (-30°C to +40°C)

The SD\*\* Series are classified as simple apparatus and are intended for use in Zone 2 or safe areas only, because their fuses are not fully encapsulated.

## Installation

### Positioning

The SDs should be mounted on the field wiring side to ensure that any surges entering from the field do not damage any intrinsically safe barriers or galvanic isolators in the system. The SDs and IS interfaces should be mounted close to each other but on separate DIN rails in order to maintain the required 50mm clearance between safe area and hazardous area terminals.

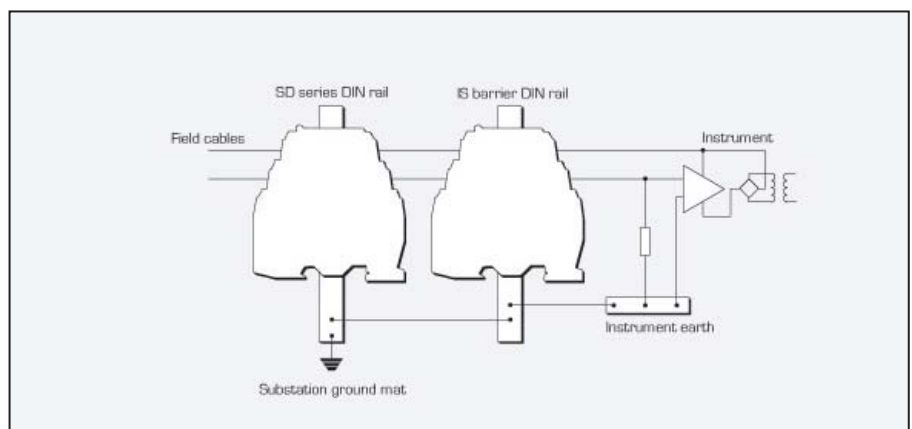

## Earthing

The recommended earthing for field mounted devices has been illustrated previously but it is the earthing at the control panel that is more critical as there are usually a number of earthing systems, each with their own requirements. The earthing system illustrated here replaces the instrument OV bond, the control system PSU bond and the IS earth with one single earth connection to meet all the design requirements and give the most effective protection against the effects of lightning induced surges.

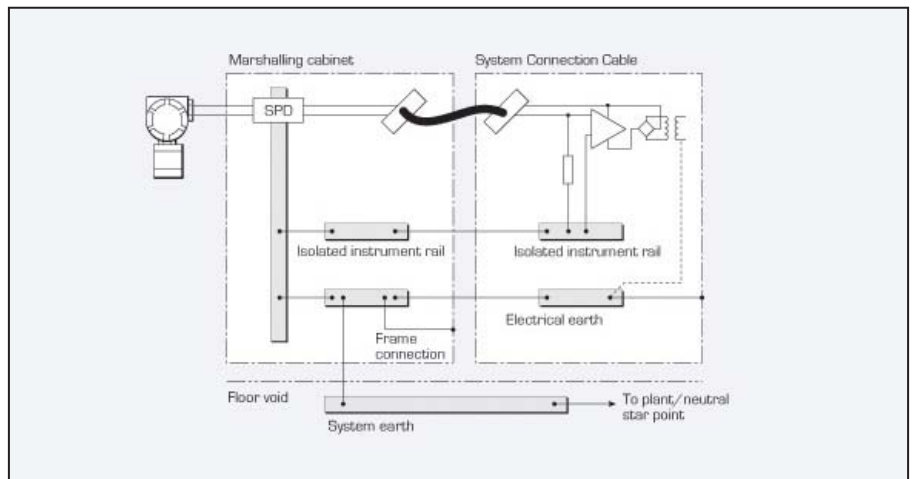

# SD Series mounting kits and accessories

The SD Series has a full range of mounting kits and accessories to simplify installation and tagging of individual loops. Insulating spacers (ISP7000) are available to allow mounting of the units onto backplanes without compromising correct earthing practice. These are placed at regular intervals along the rail or at each end as required. Earth connections can be made to the DIN rail via the earth terminal (ETL7000). Weatherproof enclosures are also available with all the necessary mounting accessories to install the SD series surge protection devices.

Two tagging systems are available. One consists of tagging strips (TAG57) with labels (TGL57) mounted on posts (IMB57) at each end of a row of surge protection devices (SPDs). The other consists of separate tagging identifiers (BRI7000) mounted on the tops of individual SPDs. Both methods can be used conjointly. Replaceable fuses or solid links are available in packs of 5 (SD-F25, SD-F05 and SD-LNK).

## Mounting accessories

- ISP7000 Insulating spacer
- THR2 Standard DIN rail, 35mm x 7.5mm
- THR7000 T-section DIN rail, specially nickel plated, 35mm x 7.5mm, 1m length

## Earthing/earth rail accessories

- ETL7000 Earth terminal, DIN rail mounted
- IMB57 Insulated mounting block (two needed)
- ERB57S Earth rail bracket, straight
- ERB57O Earth rail bracket, offset
- ERL7 Earth rail, 1m length
- ETM7 Earth terminal, pack of 50

## Tagging accessories

- TAG57 Tagging strip, 1m length
- TGL57 Tagging strip labels, set of 10 x 0.5m
- BRI7000 Barrier identifier
- BIL7000 Barrier identification labels, sheet of 120
- BIL7000L Barrier identification labels, A4 sheet of 126

## Enclosures

- DX070 Enclosure for up to 9 x SD series SPDs
- DX170 Enclosure for up to 22 x SD series SPDs
- DX430 Enclosure for up to 58 x SD series SPDs

## Accessories (replacement)

- SD-F25 Replaceable fuse pack - 250mA standard (available in packs of 5)
- SD-F05 Replaceable fuse pack - 50mA special (available in packs of 5)
- SD-LNK Solid Link (available in packs of 5)

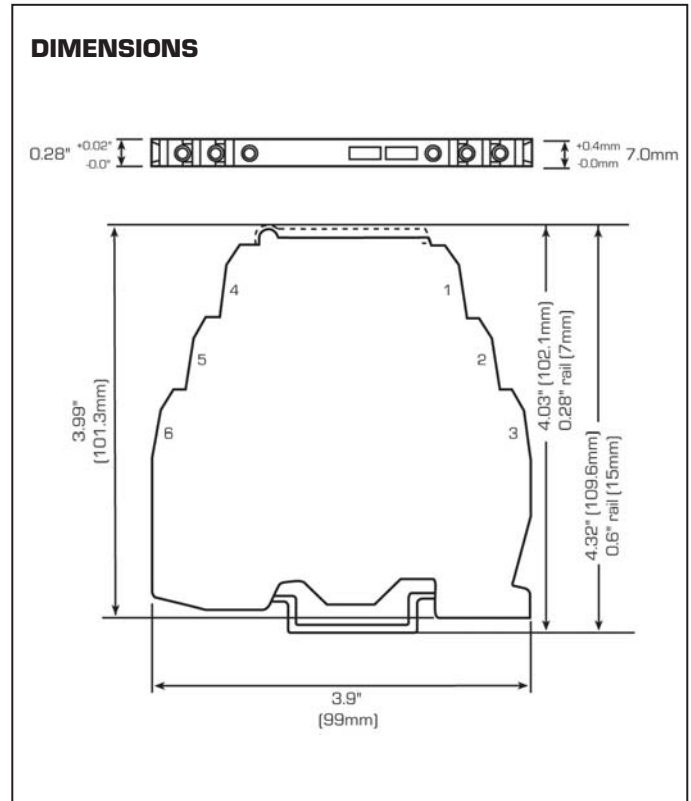

## SIL information

Failure rates according to IEC 61508

	$\lambda_{SD}$	$\lambda_{SU}^*$	$\lambda_{DD}$	$\lambda_{DU}$
SD07, SD16, SD32, SD55	0 FIT	75 FIT	15 FIT	2 FIT
SD07R, SD16R, SD32R, SD55R	0 FIT	46 FIT	15 FIT	2 FIT
SD07X, SD16X, SD32X, SD55X	0 FIT	47 FIT	15 FIT	2 FIT
SD07R3, SD07T3, SD07X3	0 FIT	73 FIT	20 FIT	7 FIT
SD16R3, SD16T3, SD16X3, SD32R3, SD32T3, SD32X3, SD55R3, SD55T3, SD55X3	0 FIT	72 FIT	18 FIT	6 FIT
SDRTD	0 FIT	71 FIT	20 FIT	9 FIT

The user of the SD Series can utilize these failure rates in a probabilistic model of a safety instrumented function (SIF) to determine the suitability in part for safety instrumented system (SIS) usage in a particular safety integrity level. A full table of failure rates is presented in the EXIDA report (section 4.4) along with all assumptions.

\*The Residual Effect failures are included in the Safe Undetected failure category according to IEC 61508. Note that these failures alone will not affect system reliability or safety and should therefore not be included in spurious trip calculations.

Safe Failure Fraction needs to be calculated on (sub)system level.

A complete copy of the EXIDA report can be downloaded at [www.mtlsurge.com](http://www.mtlsurge.com).



# Specification

All figures typical at 25°C (77°F) unless otherwise stated

## Protection

- Full hybrid line to line
- Each line to screen/ground

## Max. discharge surge current (I<sub>max</sub>) (8/20µs)

- 20kA (8/20µs)
- 6.5kA (SD150X and SD275X only)

## Nominal discharge surge current (I<sub>sn</sub>)

- 3kA (8/20µs)

## Lightning impulse current (I<sub>imp</sub>) (10/350µs)

- 2.8kA
- 1.0kA (SD150X and SD275X only)

## Response time

- <1ns

## RTD resistance range (SDRTD)

- 10 to 1500Ω

## Degradation accuracy (SDRTD at 1mA)

- 0.1% (RTD resistance > 100Ω)
- 0.1Ω (RTD resistance < 100Ω)

## Ambient temperature

- 40°C to +80°C - working (-40°F to 176°F)
- 40°C to +80°C - storage (-40°F to 176°F)

## Humidity

- 5 to 95% RH (non-condensing)

## Category tested

- A2, B2, C1, C2, C3

## Overstressed fault mode i<sub>n</sub>=3kA

- 12kA
- 9kA (SD150X and SD275X only)

## Impulse durability (8/20µs)

- 10kA
- 6.5kA (SD150X and SD275X only)

## Terminals

- 2.5mm<sup>2</sup> (12 AWG)

## Mounting

- T-section DIN-rail 35 x 7.5 or 35 x 15mm rail (1.38" x 0.3" x 0.6")

## Weight

- 70g approximately (2.5oz)

## Case flammability

- UL94 V-2

## AC durability

- 1A<sub>rms</sub>, 5T

## Service conditions

- 80kPa - 160kPa
- 5% - 95% RH

## EMC compliance

- To Generic Immunity Standards, EN 50082, part 2 for industrial environments

## R&TTE compliance

- EN 50082-2 : 1995
- EN 41003 : 1999
- EN 60950 : 1992 (not applicable to SD150X and SD275X)

## LVD compliance

- SD150X & SD275X
- EN 60950 : 1992
- EN 61010 : 1995
- SDPSTN
- EN 41003 : 1999

## IEC compliance

- EN 61643-21:2001

## ANSI/IEEE testing

- C62.41-1-2002
- C62.41-2-2002
- C62.45-2002

## To order specify -

- Order by module, as listed in the specification table and/or accessory part numbers as defined on page 7.

Note: In accordance with our policy of continuous improvement, we reserve the right to change the product's specification without notice.

For more information please contact your local MTL sales office:

- The Americas:** +1 800 835 7075
- UK:** +44 (0)1582 723633
- Singapore:** +65 6 487 7887
- The Netherlands:** +31 (0)481 450250
- Italy:** +39 (0)2 6180 2011
- Australia:** +61 (0)8 9455 2994
- India:** +91 (0)44 450 1660

Local sales office information is also available on our web site at: [www.mtlsurge.com/support/distribution/index.htm](http://www.mtlsurge.com/support/distribution/index.htm)

Model	Nominal voltage+ (U <sub>n</sub> )		Nominal current (I <sub>N</sub> ) (mA)	Series resistance (Ω/line)	Max. leakage current (µA)	Rated voltage (MCOV) (U <sub>c</sub> )	Voltage Protection level (U <sub>p</sub> ) @1kV/µs (V)	Residual voltage @i <sub>sn</sub> (V)	Bandwidth (Frequency) (f <sub>g</sub> )	Special feature
	(Vdc)	(Vac)								
SD07	7	5	250	4.2†	500	7.7	<12	30	25kHz	Fuse Disconnect
SD16	16	11	250	4.2†	5	17	<25	40	25kHz	Fuse Disconnect
SD32	32	22	250	4.2†	5	36	<45	60	25kHz	Fuse Disconnect
SD55	55	38	250	4.2†	5	62	<90	100	25kHz	Fuse Disconnect
SD07R	7	5	400	2.7	500	7.7	<12	30	50MHz	High Bandwidth
SD16R	16	11	400	4.7	5	17	<25	40	50MHz	High Bandwidth
SD32R	32	22	400	10	5	36	<45	60	50MHz	High Bandwidth
SD55R	55	38	400	10	5	62	<90	100	50MHz	High Bandwidth
SD07X	7	5	400	2.2	500	7.7	<12	30	25kHz	Low Resistance
SD16X	16	11	400	2.2	5	17	<25	40	25kHz	Low Resistance
SD32X	32	22	400	2.2	5	36	<45	60	25kHz	Low Resistance
SD55X	55	38	400	2.2	5	62	<90	100	25kHz	Low Resistance
SD32T3	32	22	400	2.2^	5	36	<45	60	720kHz	3 Terminal
SD07R3	7	5	400	2.7	500	7.7	<12	30	50MHz	3 Terminal
SD16R3	16	11	400	4.7	5	17	<25	40	50MHz	3 Terminal
SD32R3	32	22	400	10	5	36	<45	60	50MHz	3 Terminal
SD55R3	55	38	400	10	5	62	<90	100	50MHz	3 Terminal
SDRTD	1	0.75	10<	2.7	0.3	5	<12	30	50MHz	3-wire RTD
SDPSTN	162	114	550	4.7	5	175	<200	235	4MHz	PSTN
SD150X	170	20	3A‡	0.1	ac rms 250	dc rms 170	<400	450	-	High current
SD275X	339	240	3A‡	0.1	ac rms 250	dc rms 350	<700	850	-	High current

Note: all figures are typical at +25°C unless otherwise stated; \* standard fuse; + over full working temperature range; † at 20mA with a 250mA standard fuse; ‡ these units need external 3A fuses; ^ Signal; \*\* Power & Common; † maximum energizing current depends upon RTD resistance. See page 2 for details.

Blue color signifies products ATEX certified EEx ia IIC T4.

## Definitions of terminology used in table

### 1 Working voltage (U<sub>n</sub>)

Maximum voltage between lines or lines/ground for the specified leakage current

### 2 Maximum leakage current (I<sub>c</sub>)

Maximum current drawn by the SPD at the working voltage

### 3 Maximum continuous operating voltage (U<sub>c</sub>)

Maximum voltage that can be applied to the protected terminals without damage

### 4 Voltage protection level (U<sub>p</sub>)

Peak output voltage after injection of test impulse from 1kV/µs generator (often known as 'let-through' voltage)

### 5 Bandwidth

Frequency range up to which ac signals can be transmitted without undue attenuation; 3dB into 50Ω (600Ω for the SDPSTN)

## Approvals

Country (Authority)	Standard	Certificate/ File No.	Approved for	Product
BASEEFA (EC)	EN 50014:1997 EN 50020:2002 EN 50284:1999	BASEEFA 02ATEX0211X	EEx ia IIC T4*	SD07X,SD16X,SD32X, SD55X,SD07R, SD16R, SD32R,SD55R,SDRTD, SD32T3,SD07R3,SD16R3, SD32R3,SD55R3
CSA/C/US (Canada, USA)	CSA C22.2 No. 0-M1991 CSA C22.2 No. 157-M1992 UL 913, 5th edition CSA C22.2 No. 142-M1987 CSA C22.2 No. 213-M1987 UL 508, 17th edition UL 1604, 3rd edition	LR 103652-3	EEx ia Class 1, Groups A, B C and D, T4 Class 1, Div 2 Groups A,B,C, D T4	SD07SD16,SD32,SD55, SD07X,SD16X,SD32X, SD55X,SD07R,SD16R, SD32R,SD55R,SDRTD, SD32T3,SD07R3,SD16R3, SD32R3,SD55R3
UL (USA)	UL 497B Listed	E220693	Isolated loop communication circuits	SD07,SD16,SD32,SD55 SD07X,SD16X,SD32X SD55X,SD07R,SD16R SD32R,SD55R,SD07R3 SD16R3,SD32R3,SD55R3 SD32T3,SD55T3, SD07X3,SD16X3,SD32X3, SD55X3,SDRTD
UL (USA, Canada)	UL 1449 Recognised Component	E217523	AC power protection	SD150X,SD275X
Austel (Australia)	AS/NZ3548:1995 AS/NZS4117:1996 TS001: 1997	—	Private Wire	SD07R

\* See page 6 for further details

